

Data Sheet



Article number: 433000100

Description: Rota-fix shaft-hub connection C 100x114

Note: Not self centering. Small radial dimensions

Measures

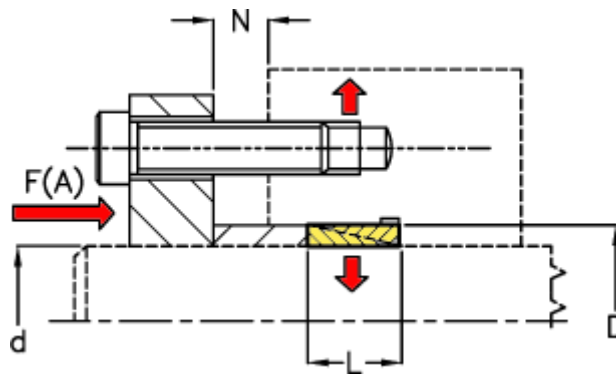

d mm = 100

D mm = 114

F(A) kN = 440

Fit tolerance = Aksel \varnothing ? 38 h6, Aksel \varnothing > 38 h8, Nav \varnothing ? 38 H7, Nav > \varnothing 38 H8

F kN torque = 84.0

L = 21

N1 = 5

N2 = 6

N3

N4

P N/mm² surface press

Surface roughness

T N m torque